

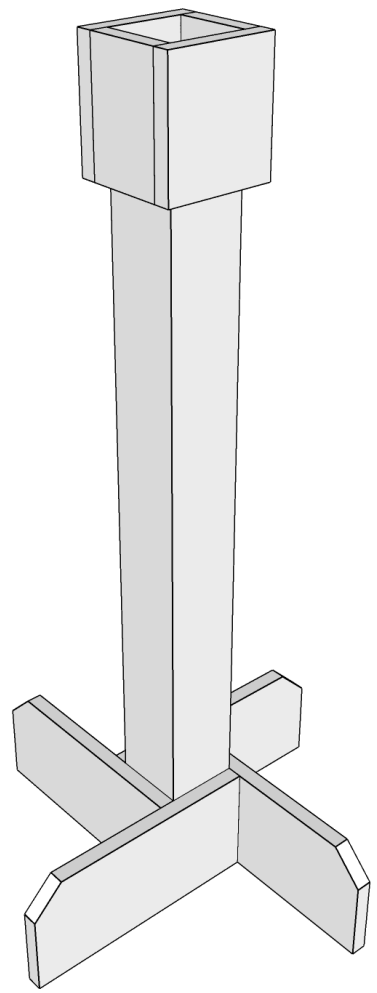

THE MISSION CONTINUES

Sanitizer Stand x2

Beginner



Dimensions
Build Time
No. of Volunteers
Avg Cost

3'x1'x1'
1 hr
1-2
\$45.00



Tools and Materials

Tools

Saw(hand, miter, circular)

Drill

Tape measure

Speed Square

Materials

**These materials may be purchased at Lowe's, a national partner of
The Mission Continues**

Item	Amount	Notes	Link
4x4x8	1		https://bityl.co/4nxA
1x6x6	2		https://bityl.co/4nxE
1 5/8" Screws	1		https://bityl.co/4nxH
1/8" Drill bit	1		https://bityl.co/4nxK
T25 Bits	1		https://bityl.co/4nxP



Cut Diagram

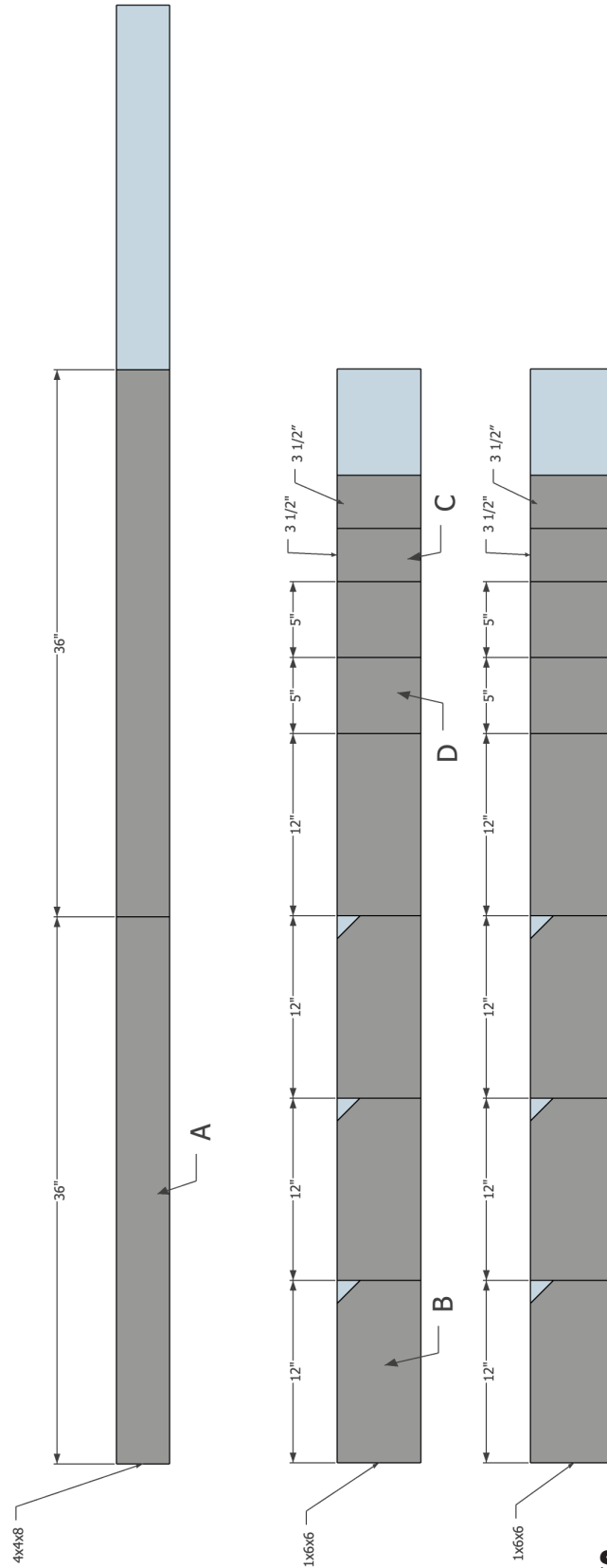

Sanitizer Stand 2



Cut Diagram

Detail: Part B

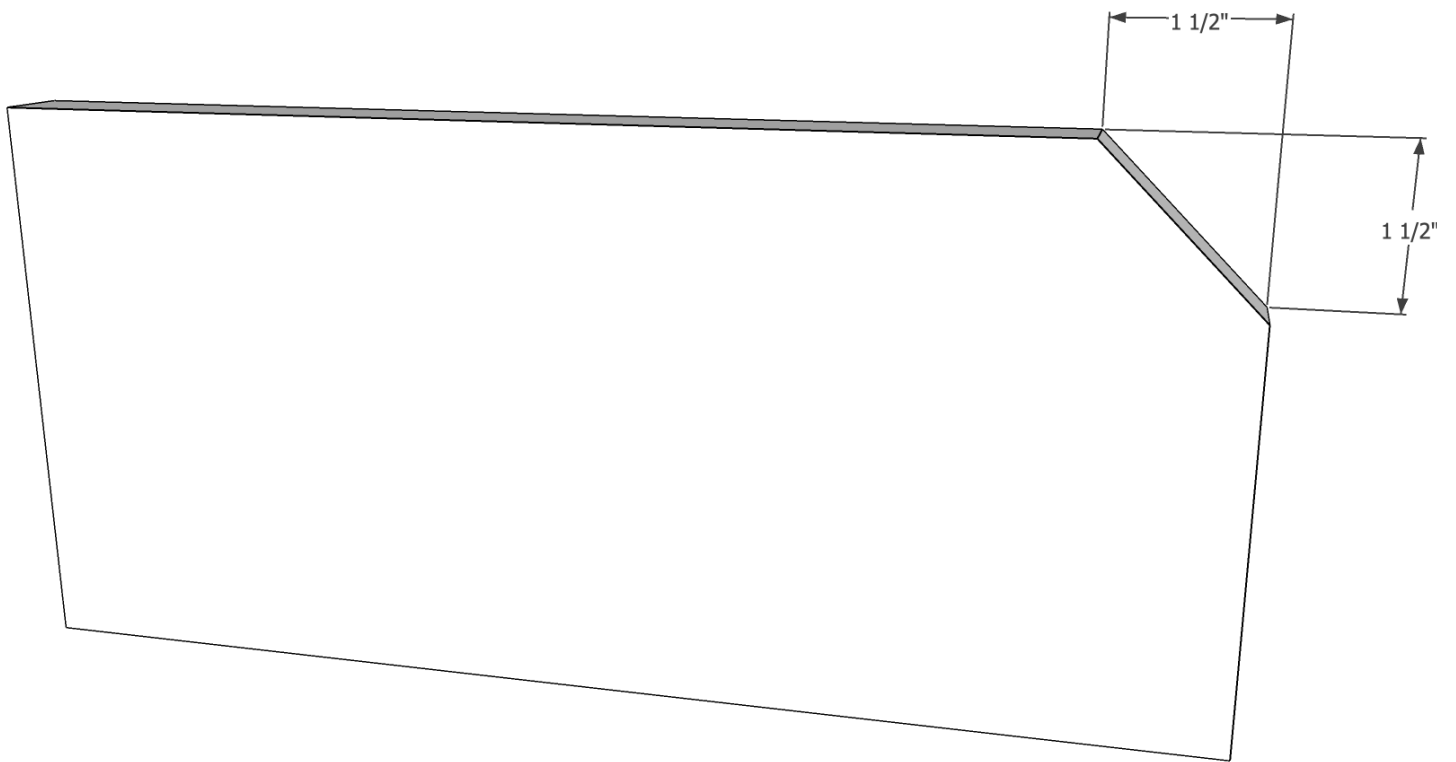

Sanitizer Stand 3



Cut List

Part Name	Measurement	Amount
A	36"	2
B	12"	8
C	3 1/2"	4
D	5"	4



Step 1: Feet

*** Drill pilot holes to avoid splitting ***

Ensure the back and bottom edges of B are flush with the edges of A and screw together.

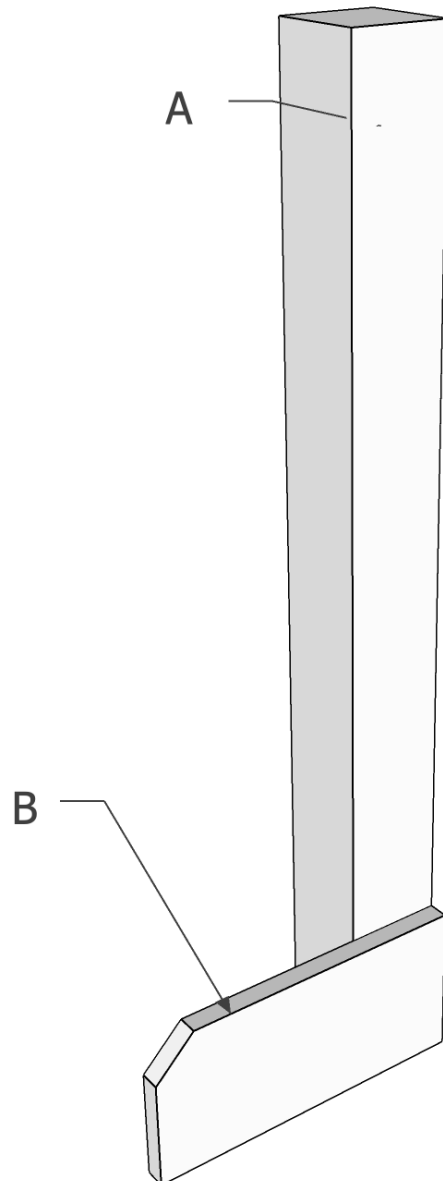



Step 1: Detail

Part B should line up with part A as pictured

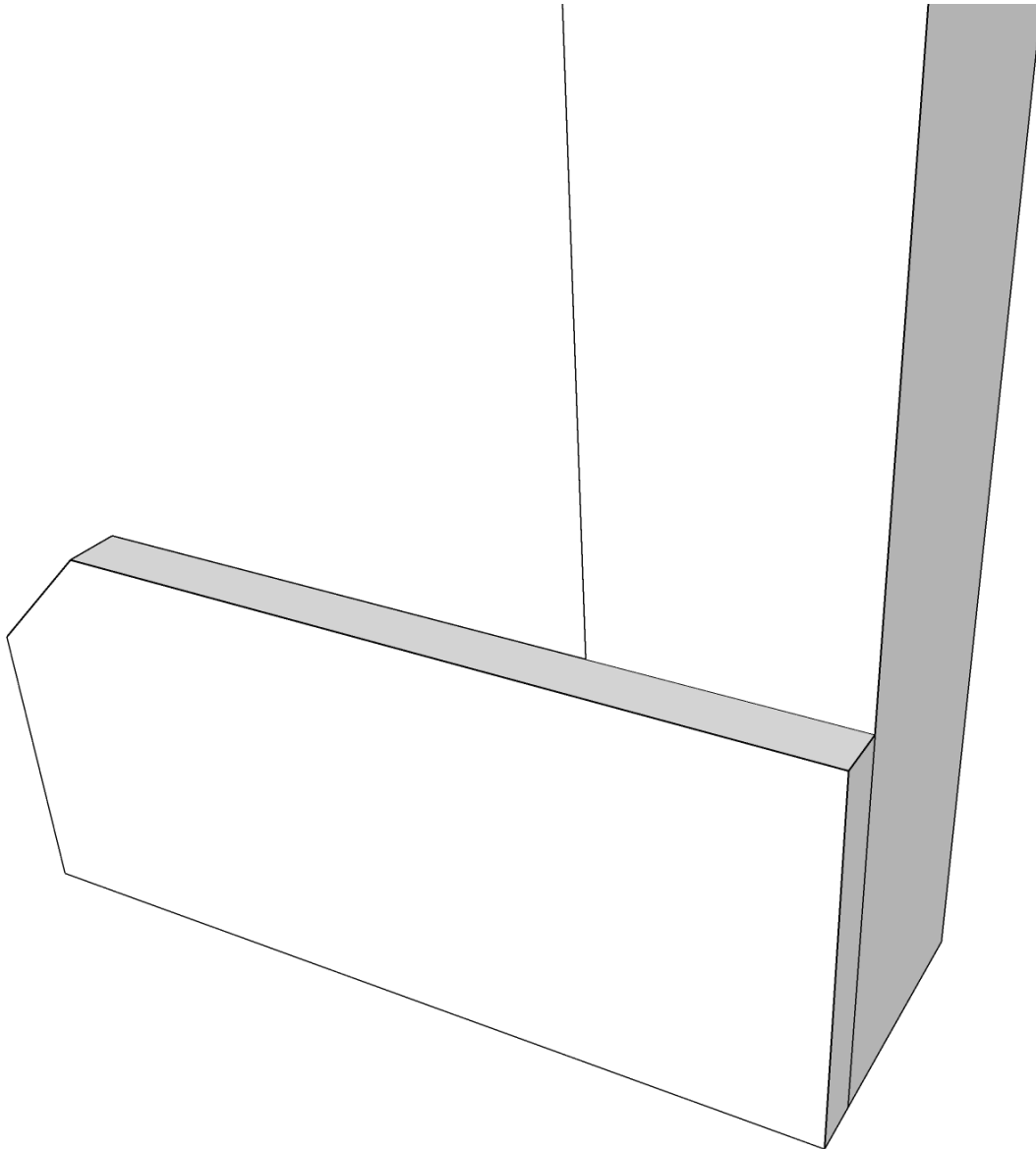



Step 1a: Feet

Attach the rest of the feet ensuring that they butt tightly against the other pieces and are flush with the bottom of A

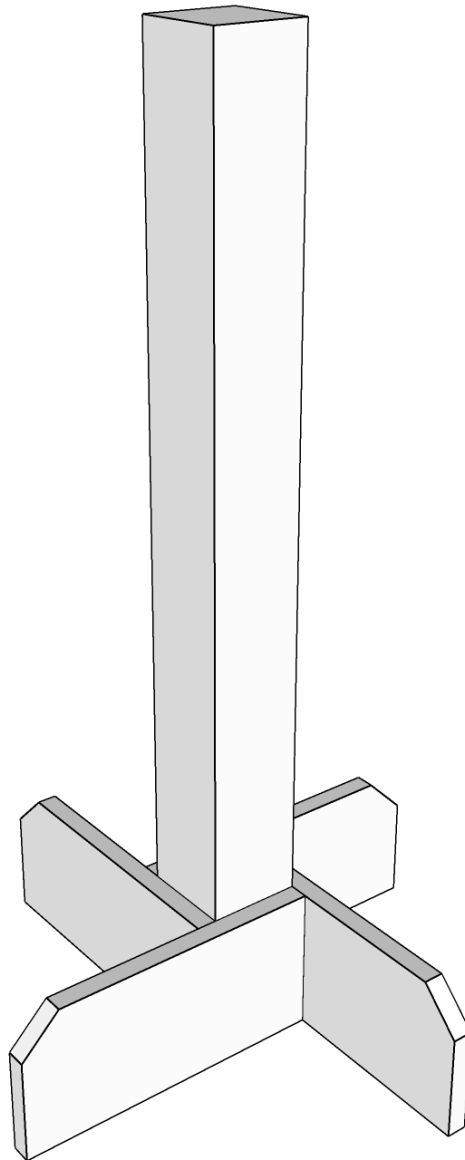



Step 2: Holder

*** Drill pilot holes to avoid splitting ***
Attach parts C to part A. C should overlap A by 2"

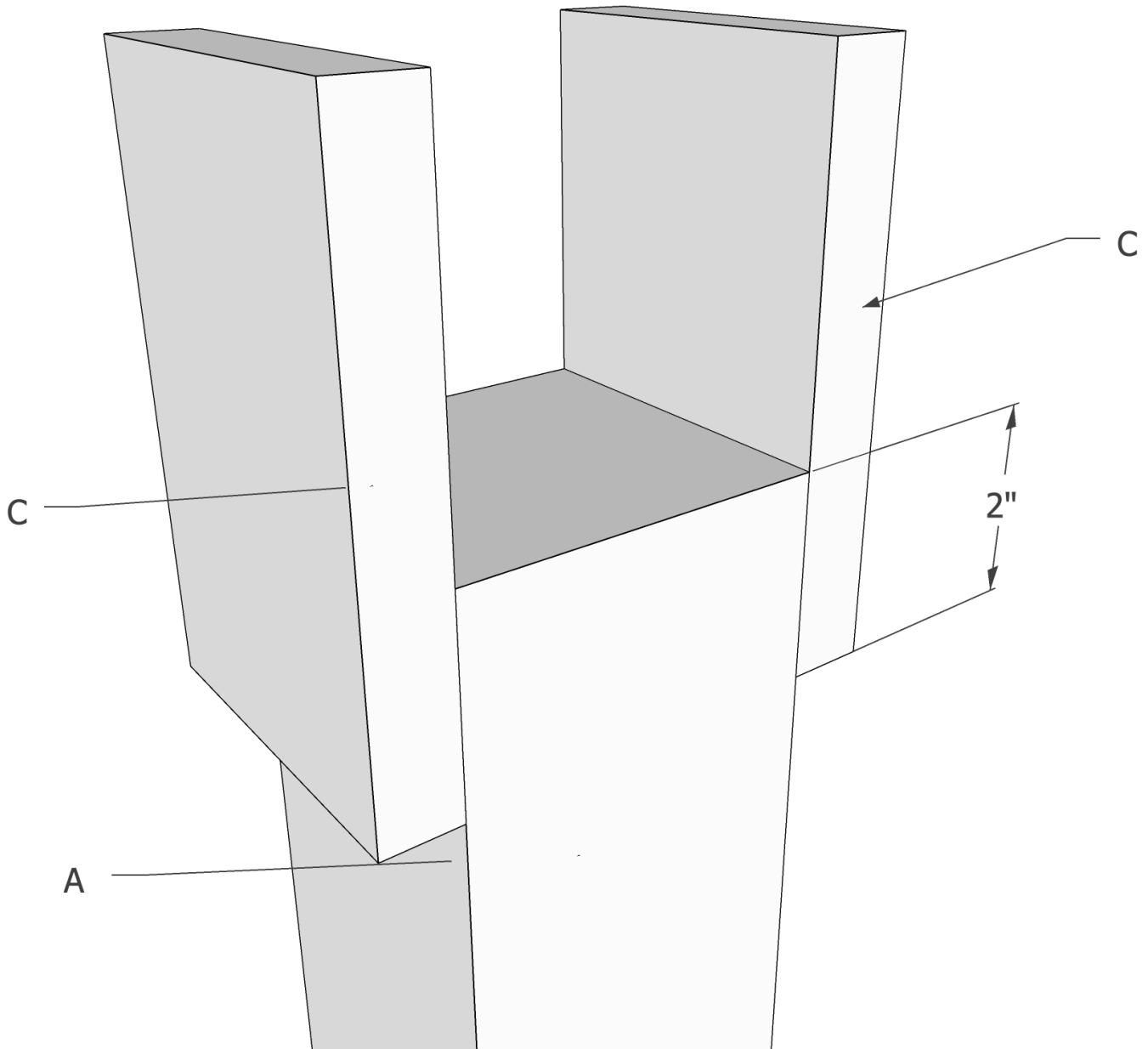



Step 2a: Finish

Attach parts D

Repeat steps to complete second sanitizer stand.

